

D-CLASS
4x141W

AURA[®]

VENOM-D4 1 DSP
DSP BLUETOOTH / USB / FM RECEIVER

USER MANUAL

Venom

DSP



PLEASE READ CAREFULLY BEFORE USING

Copyright

“△”, “△UR△” are registered trademarks. All rights reserved. This document, entirely or in any part of it, is prohibited to reproduce, as well as copy without the preliminary written permission of the manufacturer. All trademarks, logos and names of products used on the packaging and in this document are logos or registered trademarks of the respective companies. Trade brands, logos and products are used only for editorial purposes and only in the interests of such companies.

Disposal instructions

Directive Weee 2012/19/EU on waste from electrical and electronic equipment. The electrical equipment that has served its term should not be thrown out with the rest of the household waste. Please hand over it in secondary processing. To obtain the necessary information, contact the local authorities.



Important!

All illustrations given in this instructions are schematic images of objects and may slightly differ from their real appearance.

Due to the continuous finalization and improvement of the product, all technical characteristics, as well as the appearance, can be changed without prior notice.

Service life

In accordance with the law, the service life of 3 years from the date of sale of the device with a store is set for this device. The value of the service life is in no way related to the real life of the device and is exclusively an obligation in relation to the legal requirements of the Law on the Protection of Consumer Rights. Given the high quality control, reliability and degree of safety of the device, the actual duration of operation can significantly exceed the officially established service life, subject to the consumer of the rules established by the manufacturer.



Precautions.....	3
Equipment and installation	4
Connection	5
Appearance, controls	6
Sizes.....	7
Remote control.....	7
Basic operations	9
Menu:	
Sound settings	9
Preservation of DSP settings (presets)	13
Tuner settings	13
Bluetooth settings	14
System settings	14
Sources:	
Radio.....	15
USB	16
Bluetooth	17
AUX	18
Update by (firmware), reset of settings	18
Appendix for Android and iOS	18
Programming buttons on the steering wheel	18
Specifications.....	20
Warranty coupon	21

Precautions

User manual contains important security recommendations and information about the proper operation of the device. Please carefully follow all the instructions given in this guide.

1. When installing the device, avoid places with high temperature, humidity, or places where there is a lot of dust.
2. Make sure that the device and, in particular, its accessories for installation, are inaccessible to children.
3. Do not drop the device and make sure that it is not subjected to blows, as this can lead to its damage.
4. The manufacturer does not bear any responsibility for any data loss that arose due to damage to this device, its repair or for any other reason.
5. Do not disassemble the device yourself. This can lead to cancellation of the guarantee.
6. Do not use alcohol, solvents or gasoline to clean plastic parts and device display. For cleaning, use only dry soft fabric.
7. Avoid contact of the device with liquids.
8. The product is designed for use only with 12-volt electrical systems with negative grounding. The use of a device in systems with a positive grounding and/or voltage different from 12 volts can lead to damage to the car and device.



Open the package and make sure that there are inside:

1. USB resaver - 1 pc.
 2. The remote control - 1 pc.
 3. Keys for removing the receiver - 2 pcs.
 4. The main connector is 1 pc.
 5. RCA connector - 1 pc.
 6. Instruction
-

Installation of the device

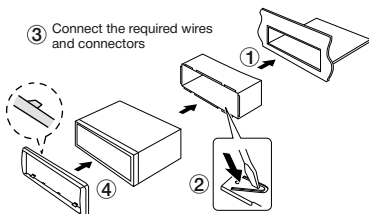

1. Install the mounting casing in the hole of the 1din standard, provided by the manufacturer. If the regular place has a 2DIN size, use transitional frames and adapters of the **AUR** brand.
2. Light out the metal tongues on the mounting casing to fix it in place.
3. Check electrical connections, connector or individual wires (depends on the configuration of a particular car model). Connect the main connector to the device. Check The system performance before fixing in the mounting casing.
4. Insert the device into the mounting casing and push it inward to fixation by click.

In some brands of cars (for example, Toyota, Honda, ...), the device is mounted by screws to standard brackets. In this case, the mounting casing is not used.

Connection

WARNING! Yellow (11 and 10) and black (2 and 1) power wires must be connected directly to the corresponding battery terminals using a copper cable with a cross section of at least 4 mm²(12GA)! Connecting to the standard wiring or to the standard ISO connector is not allowed!

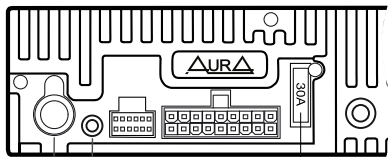

Entrance for connecting the radio antenna
(not included in the kit)

Entrance for connecting an external microphone
(Aura AMM-Mic1, is not included)

- Subwoofer, right channel ← SUB R
- Subwoofer, left channel ← SUB L
- The rear right channel ← REAR R
- The rear left channel ← REAR L
- Front right channel ← FRONT R
- Front left channel ← FRONT L

- ⊕ The rear left channel → Green (18)
- ⊖ → Green / Black (9)
- ⊕ The rear right channel → Purple (17)
- ⊖ → Purple / black (8)
- ⊕ Front left channel → White (16)
- ⊖ → White / Black (7)
- ⊕ Front right channel → Gray (15)
- ⊖ → Gray / black (6)

Connection of buttons on the steering wheel (SWC K2)

Connection of buttons on the steering wheel (SWC K1)

To the switch of the overall lights (+12v.)

Connection of buttons on the steering wheel (mass)

+12V. With the assigned ass

Managing wire +12V. (remote)

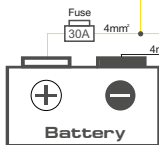
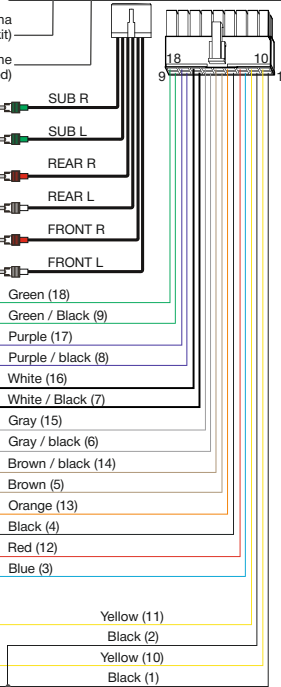

IMPORTANT! It is necessary to install an additional fuse with a face value of 30a no further than 30cm from a plus battery terminal!

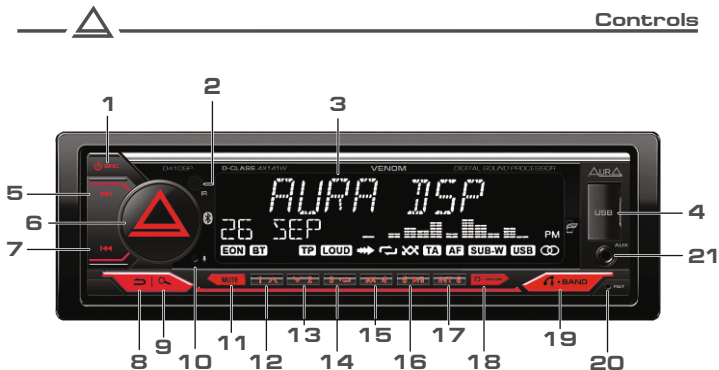

1. Turning on / off the device / Source choice
2. IR receiver
3. LCD display
4. USB slice
5. Next track / rewinding / setting up radio
6. Volume adjustment / switching / confirmation of choice
7. Previous track / rewinding back / Radio setting
8. Return
9. Search
10. Microphone
11. Muffle of sound (mute)
12. Pre -tuning button 1 / Next folder
13. Pre -setting button 2 / previous folder
14. Pre -configuration button 3 / repetition mode
15. Pre -configuration button 4 / random playback mode
16. Pre -setting button 5 / pause
17. Pre -tuning button 6 / scanning mode of tracks
18. Type of information on the display
19. Reception / Call completion / Voice Assistant / Switching
Radio ranges (FM1/2, FM3 (VHF), AM1/2)
20. Resetting to the factory settings (Reset)
21. AUX input

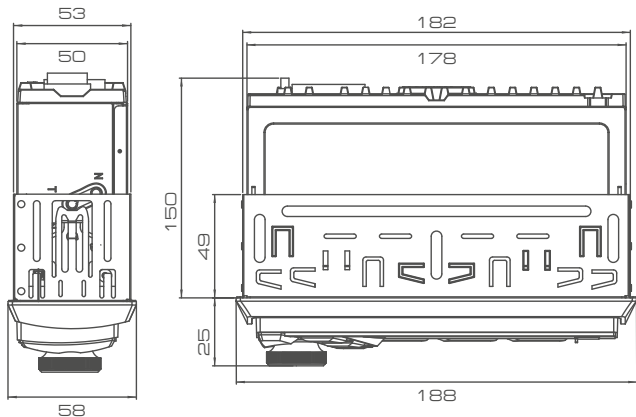

Remote control

The remote control is supplied without an element of power.
The **CR-2025** power element is purchased separately.

Installation / replacement of the nutrition element:
When the lithium battery has lost the container,
replace it as shown in the figure.

1. Pull the cell cell from the remote control in the direction, specified arrow 1.
2. Replace the old battery of the new. Follow polarity! Make sure (+) from above!
3. Insert the the battery holder into the remote control.

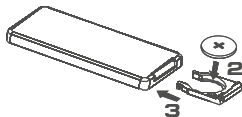
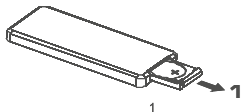



1. Turning on / off the device
2. Volume adjustment
3. Switching radio ranges
/ Reception of a call
4. Previous track / rewinding back
/ Radio setting up
5. Choosing a source
6. Next track / rewinding forward
/ Radio setting up
7. Muffling sound (mute)
8. Call completion / clock
9. Pre -configuration button 1
/ Pause
10. Preliminary settings button 2
/ Skaging mode of tracks
11. Preliminary settings button 3
/ Repeat mode
12. Preliminary settings button 4
/ Random play mode
13. Pre -configuration button 5
/ Switch to 10 tracks backward
14. Pre -configuration button 6 / Switch to 10 tracks forward
15. Radio station reception (mono / stereo)
16. Loud subtle
17. Memory scanning / Automatic search and memorization of stations (AMS)
18. Choosing a source
19. Choosing the preset of equalizer
20. Lowering of the sensitivity of the tuner (LOC)



Using remote control (PDU):

- Place the radiating window of the remote control in the direction of the sensor window on the device.
- A working angle for receiving the signals of the PDU is about 30 degrees.
- The distance between the radiation window of the DPD and the touch window of the device. It should be less than 5 meters.
- The sowing nutrition element can lead to damage to the remote control.
- Store the nutrition elements in an inaccessible place for children!

Main operations

Turning on / off

Press any button to enable the device.

Press and hold the button (1) **⏻** / **SRC** to turn off.

Volume adjustment

Rotate the volume control handle to set the desired level.

Choosing a source

Press the button (1) **⏻** / **SRC** to switch between sources

Reproduction: Radio -> USB -> Aux in -> Bluetooth.

Settings menu

Press the volume adjusting button (6) and rotate to select the necessary settings section: Audio (sound settings), Display (display settings), tuner (radio settings), Bluetooth (Bluetooth settings).

To select the desired section, press the volume control handle.

Audio

IMPORTANT! Before entering the Audio menu (sound), when the name Audio is displayed on the screen, press and hold the volume control button (6) to select the 2-or 3-strip configuration of the crossover: **2 WAY (ordinary)** or **3 WAY (network)**.

EQ SETTING

Custom - Manual setting 24 canalizer 24 (from -9 dB to +9 dB).

Settings are possible at frequencies: 45/63 / 100/125 / 160 /250 / 315/400 / 500 /630 /800 /1 / 1.25 / 1.6 / 2.5 / 3.15 / 4 /5 /6 /6 /6 /6 , 3 /8 /10 / 12.5 / 16 /20.

EQ reset - reset settings of the equalizer.

Q-factor - installing the value of the quality factor (quality).

Values: 1 / 1.5 / 2.5 / 3.5.

⋮
Natural, Rock, Pop, Easy,
Top 40, JAZZ, Powerfull.

Bass boost

Inclusion and configuration of low frequency reinforcements (5 levels).

Loudness

Inclusion and configuration of subleptent (2 levels).

**Subwoofer**

Sub-W output - turning on / disabling the subwoofer.

Sub-W level - settings of the volume level.

Sub-W stereo - subwoofer RCA output mode (Mono/Stereo).

Fader

Setting relative volume between the front and rear speakers.

Balance

Setting relative volume between the left and right channels.

Volume limit

The choice of the value of the maximum possible volume level (3 - 40 units).

Power on vol.

The choice of the volume level when the receiver is turned on (1 - 40 units).

X-OVER

Setting filters of low and high frequencies (FNCh and FVH). The settings of this menu item will be different for configurations **2-WAY / 3-WAY!**

2-WAY (Regular)

Tweeter - high frequency setting

FRQ - frequency selection: 1 / 1.6 / 2.5 / 3.15 / 4 / 5 / 6.3 / 8 / 10 / 12.5 kHz.

GAIN LEFT - volume level (left channel), from -8 to 0 dB.

GAIN RIGHT - volume level (right channel), from -8 to 0 dB.

Front HPF - FVF configuration (HPF) of the anterior speakers

F-HPF FRQ - cut frequency: trons (off.) / 30 / 40/50 / 60 /

70 / 80 / 90 / 100 / 120 / 150 / 180 / 220 / 250 / 315 / 400 / 500 / 630 / 700 / 800 Hz.

F-HPF SLOPE - the steepness of the decline: 6 / 12/18 / 24 dB per octave.

F-HPF GAIN - volume level, from -8 dB to 0 dB.

Rear HPF - FVF configuration (HPF) of the rear speakers

R-HPF FRQ - cut frequency: trons (off.) / 30 / 40/50 / 60 /

70 / 80 / 90 / 100 / 120 / 150 / 180 / 220 / 250 / 315 / 400 / 500 / 630 / 700 / 800 Hz.

R-HPF SLOPE - the steepness of the decline: 6 / 12/18 / 24 dB per octave.

R-HPF GAIN - volume level, from -8 dB to 0 dB.

Subwoofer LPF - Settings of the FNCH (LPF) and the phase of the subwoofer.

SW LPF FRQ - cut frequency: 30 / 40 / 50 / 60 / 70 / 80/90 / 100 /

120 / 150 / 180 / 220 / 250 / 315 / 400 / 500 / 630 / 700 / 800 Hz / Trough (excavation).

SW LPF PHASE - Switching the electric phase: 0 ° / 180 °

SW LPF GAIN - volume level, from -8 dB to 0 dB.

SW LPF SLOPE - the steepness of the decline: 6 / 12/18 / 24 dB per octave.

3-WAY (Network)

Tweeter - HPF setting for tweeters.

HP FRQ - Cutoff frequency: 500 / 630 / 700 / 800 / 1 / 1.6 / 2.5 / 3.15 / 4 / 5 / 6.3 / 8 / 10 / 12.5 kHz.

SLOPE (High-High Frequency Slope) - the steepness of the decline: 6 / 12 / 18 / 24 dB per octave.

PHASE (HF PHASE) - electrical phase switching: 0° / 180°

GAIN (HF LEVEL) - the volume level of the tweeters, from -8 dB to 0 dB.

Mid range - adjusting the high-pass filter (HPF) and low-pass filter (LPF) of the midrange speakers

HPF FRQ (MF-HPF) - HPF cutoff frequency (HPF): THROUGH (off) / 30 / 40 / 50 / 60 / 70 / 80 / 90 / 100 / 120 / 150 / 180 / 220 / 250 / 315 / 400 / 500 / 630 / 700 / 800 Hz.

HPF SLOPE (MF-HFT DECAY) - the steepness of the decline: 6 / 12 / 18 / 24 dB per octave.

LPF FRQ (MF-LPF) - cutoff frequency: 500 / 630 / 700 / 800 / 1 / 1.6 / 2.5 / 3.15 / 4 / 5 / 6.3 / 8 / 10 / 12.5 kHz / THROUGH (off).

PHASE (MF PHASE) - electrical phase switching: 0° / 180°

LPF SLOPE (MF-LPF SLOW) - the slope of the LPF slope (LPF): 6 / 12 / 18 / 24 dB / oct.

GAIN (MIDDLE LEVEL) - the volume level of the midrange speakers, from -8 dB to 0 dB.

Woofers - low-pass filter (LPF) and subwoofer phase adjustment

LPF FRQ (SUB LPF) - cutoff frequency: 30 / 40 / 50 / 60 / 70 / 80 / 90 / 100 / 120 / 150 / 180 / 220 / 250 / 315 / 400 / 500 / 630 / 700 / 800 Hz THROUGH (off).

SLOPE (SAB-LPF SLOW) - the steepness of the decline: 6 / 12 / 18 / 24 dB per octave.

PHASE (SUB PHASE) - electrical phase switching: 0° / 180°

GAIN (SUB LEVEL) - subwoofer volume level, from -8 dB to 0 dB.

X'over reset

Reset crossover settings.

DTA SETTING - delay setting

Per-channel setting of signal time delays. The settings of this menu item will be different for configurations **2-WAY / 3-WAY!**

IMPORTANT! The delay setting starts from the farthest speaker from listening position (usually a subwoofer).

The farthest speaker does not need additional delay.

The rest of the speakers must be corrected according to the difference between the distance from the farthest speaker and the distance from the calculated speaker to the listening position.

Make the necessary calculations for all speakers, then make the settings in the app or in the receiver's menu.

2-WAY (Regular)

Position - choice of listening position.

All / Front Left / Front Right / Front All.



Delay - value for each channel.

Front left - front left
Front right - front right
Rear left - rear left
Rear right - rear right
Sub-W left - subwoofer left
Sub-W right - subwoofer right

Gain - volume value of each channel

Front left - front left
Front right - front right
Rear left - rear left
Rear right - rear right
Sub-W left - subwoofer left
Sub-W right - subwoofer right

3-WAY (Network)

Position

Listening Position Selection: All / Front Left / Front Right / Front All.

Delay - value for each channel:

Front left - MF/LF left
Front right - MF/LF right
Rear left - HF left
Rear right - HF right
Sub-W left - subwoofer left
Sub-W right - right subwoofer.

Gain - volume value of each channel

Front left - MF/LF left
Front right - MF/LF right
Rear left - HF left
Rear right - HF right
Sub-W left - subwoofer left
Sub-W right - right subwoofer.

DTA reset

Reset delay settings.

Delay units

Select the unit of measurement: centimeters or milliseconds.

Car type

Vehicle type selection: Sedan / Station Wagon / Minibus.

DSP Presets

You can save 6 independent settings (presets) and quickly switch between them.

IMPORTANT! Settings are retained when the battery power is turned off.

1. Adjust the EQ, delay and crossover settings.
2. Exit the "Audio" menu.
3. hold down the volume knob (encoder) for 3 seconds. "DSP KEYS" ("memory") will flash on the bottom line of the display.
4. To save the current settings to the memory cell "1", hold down the button "1" for 2 seconds. "Preset 1" will appear on the bottom line.
5. Hold down the volume knob (encoder) for 3 seconds to exit the save settings mode.
6. Change the EQ, delay and crossover settings.
7. Exit the "Audio" menu.
8. hold down the volume knob (encoder) for 3 seconds. "DSP KEYS" ("memory") will flash on the bottom line of the display.
9. To save the current settings to the memory cell "2", hold down the button "2" for 2 seconds. "Preset 2" will appear on the bottom line.
10. Briefly press the "1" button to recall the settings stored in "preset 1" ("preset 1").
11. Briefly press the "2" button to recall the settings stored in "preset 2" ("preset 2").

DISPLAY - display settings

Color select

Setting the color of the RGB backlight.

Spectrum

Frequency spectrum display, on/off.

Dimmer

Backlight dimming settings, on/off.

Dimmer timer - dimming the backlight by time.

TUNER - radio function settings

Local seek

Local search, on/off

Stereo set

Stereo mode, on/off



Regional

Broadcast region selection (Europe, USA, Asia, Russia).

RDS set

Turn on the text messaging system.

TA set

Traffic announcements.*

AF set

Transition to more stable frequencies.*

EON set

Auto switching to traffic channels.*

Radio text

Displaying text information.

PI regional

Station name display.

PTY search

Search by program type.*

*function is not supported in Russia.

BLUETOOTH

PIN-code edit

Changing the BT pairing PIN.

MIC gain

BT microphone level adjustment.

SYSTEM

Language

Selecting the menu display language.

Clock - clock setting

Clock format - selection of clock display format (12 / 24 hours).

Clock adjust - setting hours / minutes.

Data format - select date display format.

Data set - setting date values.

Time sync - exact time synchronization via RDS.

Beep - button sound

Enable / disable sound when buttons are pressed.

AUX IN

Enable/disable AUX source.

SWC

Programming regular steering wheel buttons.

Detailed description of the programming procedure on page 18.

Car ACC - ignition lock type

Yes - set for the car with ACC position, the red power wire of the device is connected to the ACC position of the ignition switch.

No - set for the machine without the ACC position, the red power wire is connected to constant +12 volts.

The BT module and USB connector will be disabled when the device is turned off.

Animation - animation on display

Enabling and setting the delay interval before playing the animation on the device display: no / 15 / 30 sec. / 1 / 2 / 4 min.

Demo mode

Enable / disable demo mode.

Factory reset

Reset / return to factory settings.

Version

Viewing the current software version (firmware).

Overheat

Overheat protection: 90° / 100° / 110°

Radio

Storing and recalling radio stations

Press and hold one of the number buttons (1-6) to memorize the current radio station.

Press one of the number buttons (1-6) to recall the current radio station.

It is possible to store 6 radio stations in each broadcast band.

Range selection

Press the (19) **BAND** button to select the broadcast band radio stations:

FM1, FM2, FM3 (VHF), AM1, AM2.

Automatic search for radio stations

Press the button (7) ◀◀ or (5) ▶▶ to quickly search for stations.



Automatic search and storage of stations

Press and hold the **SEARCH** button (9) for more than 2 seconds. The unit will quickly search and automatically store 18 FM and 12 AM radio stations with strong signals.

Manual search for radio stations

Press the button (7) ◀◀ or (5) ▶▶ to change the frequency step by step. Hold down the button (7) ◀◀ or (5) ▶▶ to enter the auto tuning mode.

USB

Connect the USB storage device to the connector on the front panel of the device. Playback of supported file formats will start automatically. The USB connector supports charging mobile devices.

IMPORTANT! There is a large selection of free and other software for encoding FLAC (16bit/44.1kHz), Mp3 and WAV files on the market, and depending on the encoding status and file format, poor playback quality or noise may occur during playback. Playback is not possible in some cases.

Switching tracks

Press the button (7) ◀◀ or (5) ▶▶ to move to the previous or next track.

Rewind

Press and hold button (7) ◀◀ or (5) ▶▶ to rewind back or forward..

Play/Pause

Press the button (16) ▶/|| to stop playback. Press again to resume playback.

Scanning tracks

Press the (17) **INT** button to play in sequence for 10 seconds every track. Click again to stop scanning.

Repeat

Press the button (14) to select the repeat playback mode:
Repeat folder - Repeat playback of all files in the current folder.
Repeat one (repeat track) - repeat playback of the current file.
Repeat all (repeat all) - repeat playback of all files on the media.

Random play

Press button (15) to select random play mode:
Random folder / Random All / Random Off.

Switching folders and tracks

Press the button (13)  or (12)  to switch to the previous or next source folder. Press and hold the (13)  or (12)  button to move 10 tracks backward or forward.

BLUETOOTH

Phone pairing

Pair your phone with the VENOM-D41DSP receiver:

1. Turn on Bluetooth on your mobile device.
2. Find "VENOM-D41DSP" in the list of available BT devices and connect to it. Authorization PIN: 1234 .
3. In case of successful connection, the "BT" indicator on the receiver's display will stop blinking and will light up constantly.
4. The audio signal from the mobile device (music and calls) will be transmitted to the car speakers.

Outgoing call

Dial the subscriber's number on your phone. The call will be made on speakerphone.



Incoming call

When an incoming call comes in, the caller's number will be displayed on the receiver's screen. Press the button (19)  to receive a hands-free call.

Ending call

To reject an incoming call or end a conversation, press and hold the button (19) .

Call to the last dialed number

Press and hold the button (19)  on the receiver to call the last number in your phone's outgoing call list. Press the button (19)  on the receiver to activate the Siri function.

Switching between phone and speakerphone

During a call, press the button (19)  to transfer audio from the speakerphone to your phone or from your phone to the speakerphone.

Volume control

Rotate the volume knob during a call to adjust the volume level. Press the (11) **MUTE** button to mute the sound.



The VENOM-D41DSP receiver supports Bluetooth audio transmission protocol. After successfully pairing your mobile device with the receiver, you will be able to play music from your phone on the car audio system.

To switch tracks, press the buttons (7) ◀◀ or (5) ▶▶.

To stop playback, press the button (16) ▶/||.

AUX

You can connect an external source to the 3.5mm jack on the front of the receiver using an AurA AUX cable (sold separately).

Reset settings

Press and hold for 10 seconds. button (20) **RST** to reset the device to factory settings.

Software update

We are pleased to offer the option to update the firmware to bring you the best performance and the latest features for your device.

Please check the availability of the new software version on the website www.aurael.ru

Phone app

Most device settings are available in the AurA Audio mobile app for Android or iOS.

You can control the VENOM-D41DSP receiver from your smartphone:

1. Install the AurA Audio app from Google Play or the App Store.
2. Connect your smartphone to the receiver via Bluetooth.
3. Launch the AurA Audio app to control the receiver.

Steering wheel button setup

This function can only be implemented in cars with resistive control buttons, the common wire of the buttons is connected to the car's ground.

For the steering wheel buttons to work correctly, you must first connect the wires of the standard control panel to the 3.5 mini-jack AurA SWC-001 adapter cable (supplied separately).

The ground wire (WHEEL GND) of the standard control panel must be connected to the black GND wire, and the WHEEL KEY A and WHEEL KEY B signal wires must be connected to the K1 (red) and K2 (white) wires of the AurA SWC-001 cable, respectively.

Steering wheel button setup

The operating voltage range with the remote control buttons connected is from 0.3 to 3.3 V.

The minimum difference in operating voltages, which are set at the output of the remote control after pressing the buttons, must be at least 0.3 V.

Otherwise, in some cases, the buttons may be perceived as one.

IMPORTANT!

The manufacturer does not guarantee the correct operation of the device with all car models and is not responsible for possible problems with the car or the device that have arisen in the event of incorrect connection of the device to the car's standard wiring.

For proper connection of the standard resistive remote control, consult with the official dealer of your car or contact a certified installation center.

Button Setup Procedure:

1. Select the SYSTEM menu.
2. Enter the SWC section and select one of the two memory banks (SWC 1 or SWC 2).
3. Enter the ENABLE menu item and select YES.
4. Press the back button and select PROGRAM.
The message PRESS KEY 1 flashes on the display.

Follow next steps:

1. Press the button located on the steering wheel to assign a function to it.
CHOOSE KEY 1 flashes on the display.
2. Select one of the buttons on the head unit to which you want to assign a function.
If the assignment is successful, the message PRESS KEY 2 will flash on the display.
3. Repeat these operations (1-2) as many times as you want to assign functions to the buttons on the steering wheel.
4. Press the knob on the front panel to save the data.
The display will show SAVED x KEYS, then the unit will return to the SWC menu..

Note.

A total of 9 programming functions are available. To disable programmed button settings, enter the SWC menu and select the ENABLE option and set it to NO.

**Main**

Operating supply voltage:	12 V (allowable limits 9.6 - 15 V)
Fuse:	30 A
Maximum output power:	4 x 141W (4 ohms)
Rated output power:	4 x 71 W (4 ohms)
Speaker Impedance:	4 ohm
Frequency response:	20 Hz - 20 kHz
Display viewing angle:	vertical $\pm 30^\circ$, horizontal $\pm 15^\circ$
Audio signal input (AUX, stereo):	one (on the front panel, 3.5 mm)
Line output (RCA):	6-channel (3 pairs)
RCA output level:	up to 4 V
Maximum current consumption:	30 A
Mounting dimensions (W x D x H):	182 x 150 x 53 mm
Temperature (working):	From 0°C to +60°C
Humidity (working):	from 45% to 80%

USB

Supported media:	USB
Supported formats:	FLAC (16 bit), WAV, APE, AAC, MP3
File system:	FAT32
USB stick:	USB 2.0 / 3.0, up to 256 Gb
ID3 Tag support:	English, Russian

Bluetooth

Version:	4.2
Profiles:	A2DP, AVRCP, HFP
Frequency:	2,4 GHz

Radio FM, AM

Radio tuning memory:	18 FM, 12 AM
FM frequency range:	87.5 - 108.0 MHz
VHF frequency range:	65 - 74 Mhz
AM frequency range:	522 - 1620 kHz
Antenna impedance:	75 ohm

AUX IN

Audio input level:	500 mV (maximum 2 V)
--------------------	----------------------

DSP:

Crossover	30-12500Hz, 6-24dB/oct.
Equalizer	24 bands, 45-20000 Hz
Gain	-9dB to +9dB, 0.1dB step
Phase rotation	0 / 180°
Time delays	0-25ms, 0-850cm



WARRANTY CARD

Model name

Serial No.

Buyer name

Buyer address
Phone No.

Sales date

Signature

Seller name/stamp



TERMS OF WARRANTY SERVICE

The manufacturer guarantees the high quality and reliability of the products provided that the technical requirements described in

Operating Instructions. This warranty is issued for a period of one year from the date of purchase and is provided in the event that the product is found to be defective due to inadequate quality of materials or workmanship of the manufacturer.

Obligations under this warranty are performed on the territory of the Russian Federation by the manufacturer, selling organizations - authorized dealers of the manufacturer and service centers indicated on the manufacturer's website.

The product is not subject to warranty repair if it has the following features:

1. The fact that water or other liquids get inside the product;
2. Incorrectly completed warranty card or its absence;
3. Unqualified installation (connection of the product is not appropriate power section of wires, placement in place, hindering product cooling).
4. Intervention in the design of the product.

In case of disputes for reasons not included in the above list, the decision is made by the Authorized Service Center after a technical examination.

Parts with a limited life span (batteries, fuse links, etc.) are not covered by this warranty.

This warranty is not valid if the product is used for industrial purposes. All terms of this warranty are in accordance with applicable consumer protection laws.

Additional information on the website www.aurael.ru

CE EAC



 App Store

 Google Play



www.aurael.ru



Due to continuous product development and improvement, all specifications and appearance are subject to change without notice.

© AURA Electronics Inc. All rights reserved.