

Frequency response graphs

VENOM-6

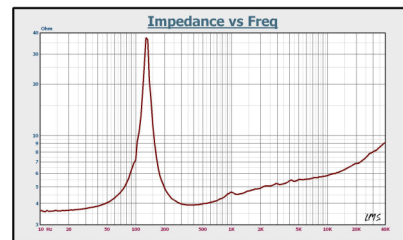
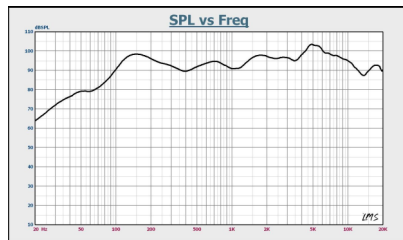

Technical features:

Power RMS (Watts)	121
Maximum power (Watts)	241
Nominal impedance (Ohm)	4
Real impedance (Ohm)	3.2
Voice coil diameter	1.5" (38.1mm)
Magnet structure weight	20 Oz (567g)
Frequency response (Hz)	90-14000
Resonant frequency Fo (Hz)	128
Mechanical Q (Qms)	7.928
Electrical Q (Qes)	1.095
Total Q (Qts)	0.962
Compliance Volume (Vas)	4.165
SPL (dB)	94
Overall depth (mm)	77
Mounting depth (mm)	68
Overall diameter (mm)	165
Mounting diameter (mm)	146

AURA[®]

OWNER'S

MANUAL

VENOM-6

MID-FREQUENCY DRIVER

www.aurael.ru



WARNING!

PLEASE READ CAREFULLY BEFORE USING

Due to continuous product development and improvement, all specifications are subject to change

©2019 AURA Electronics Inc. All rights reserved.

Introduction

Thank you for purchasing **AURA** speaker systems. We strongly recommend using the services of a professional installation studio to install your speakers. The correct configuration of the system and the qualifications of specialists will allow you to maximize the potential of your speaker systems, avoid unpleasant situations, as well as eliminate connection errors and possible malfunctions.

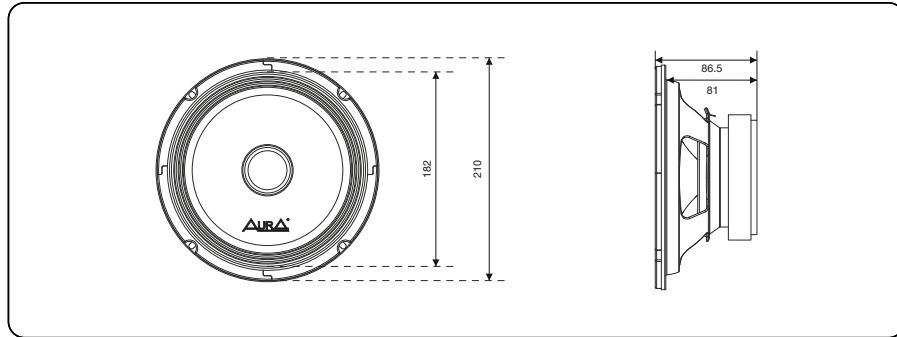

Precautions

To ensure effective performance, the speakers are recommended to be used at an ambient temperature of at least 5 °C. Install speakers only in a dry and well-ventilated area.

To ensure safe movement, it is recommended to set the volume on the sound reproducing system so that it does not interfere with all the noise of the surrounding traffic.

Description

- 6.5 "(16.5cm) Stamped metal basket
- 6.5 "(16.5cm) Durable cellulose diffuser
- 1.5 "(3.81 cm) High Temperature Voice Coil
- Poly-cotton centering washer
- Recommended HP Crossover Cutoff Frequency: 250Hz / 12dB

Package bundle

1. Acoustic systems (x 2).
2. Installation and connection manual (x 1).
3. Mounting screws 4x25mm (x 8).
4. Mounting clip (x 8).
5. Protective metal grills with plastic frames (x 2).
6. Warranty card (x 1).
7. Installation template (x 1).
8. Logo sticker (x 1).

Installation

Installation in the car door.

You can install your speakers in the front or rear doors of your car

- make sure that nothing bothers you in the chosen place of installation of speakers
- there may already be mounting holes on the inner door partition. In this case, it will be enough for you to prepare only the outer skin.
- check that the speaker terminals, basket or speaker magnet do not come into contact with internal parts and mechanisms in the door (glass, opening mechanisms, etc.). Also, make sure that the safety grill does not overlap the door handles, window buttons, etc.

1. Stop the vehicle engine. Connecting components while the power is on may damage your speakers.
2. Use the provided template for marking on site.
3. Trace the outlines of the speaker mounting hole and mounting holes. (fig. 1)
4. Cut out the marked hole and drill the locations for the mounting bolts. (fig. 2)
5. Remove the protective grill (fig. 3)

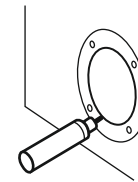

fig.1

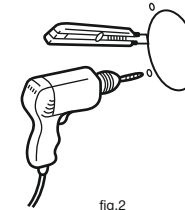

fig.2

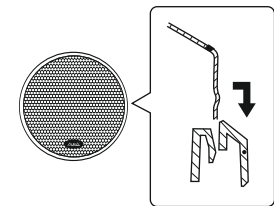
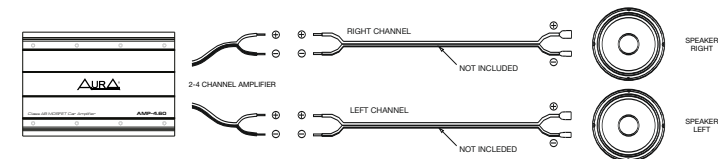
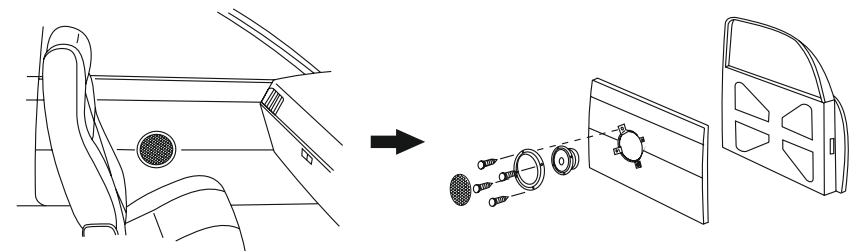

fig.3

6. Strip the speaker cables on one side and connect them to the amplifier as shown in the figure below. Pay attention to the polarity when connecting. If connected incorrectly, the low-frequency range level may be reduced.
7. Strip the speaker cables on the other side and use 4.8 mm speaker terminals.



8. Install the speakers as shown in the illustration below.



9. Install and secure the safety grill to the speakers.

